

### EMILY

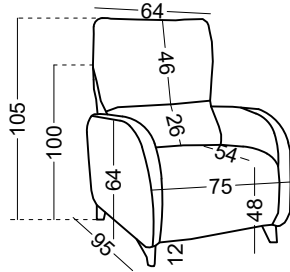

### GEORGE

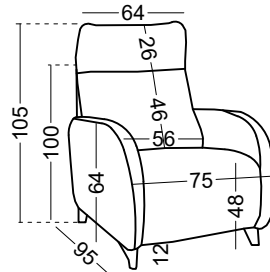

### JANE

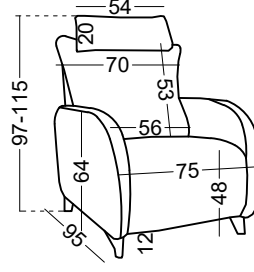

### HERMAN

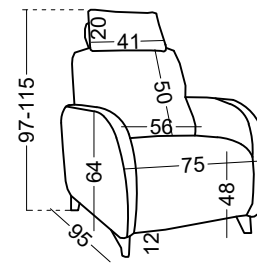

F

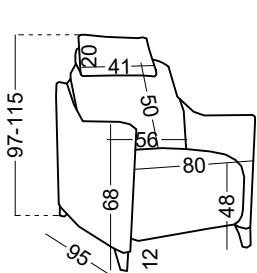
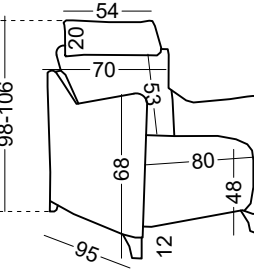
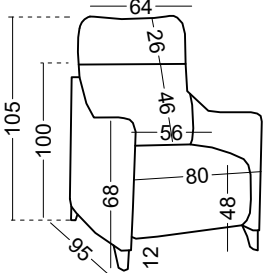
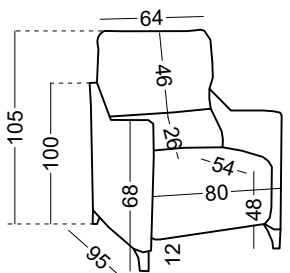

G

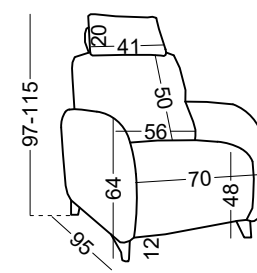
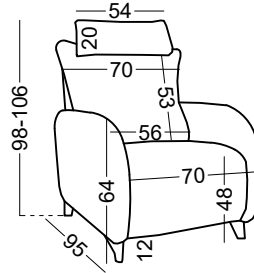
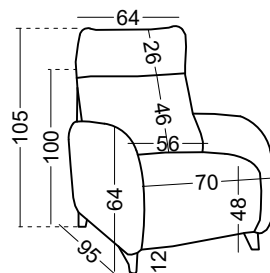
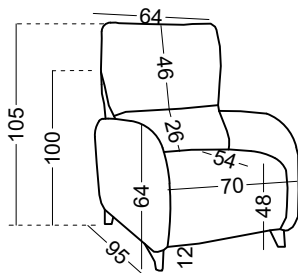

J

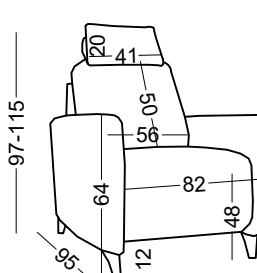
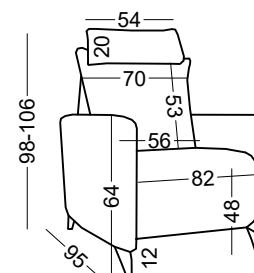
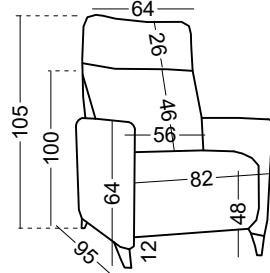
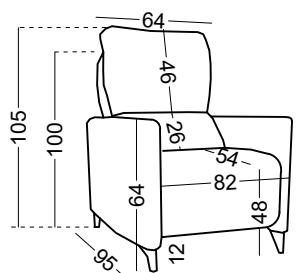

H

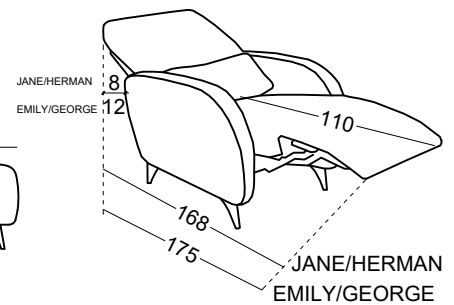
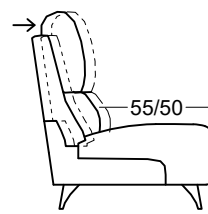
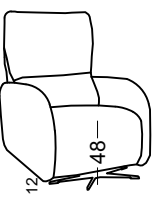
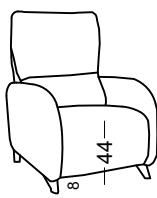
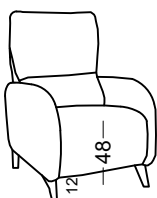

JANE/HERMAN  
EMILY/GEORGE

Es importante tener en cuenta que las medidas especificadas en catálogo, son informativas, y pueden ofrecer pequeñas diferencias.

All the measures, volumes and weights shown within this price list should be considered as informative; there may be little differences.

Les mesures indiquées dans ce tarif sont données à titre indicatif et peuvent légèrement variées en fonction de la nature des choix de tissus, de garnissage ou de finitions.

Alle Maße des Katalogs sollen nur als Information gesehen werden. Man kann kleine Unterschiede finden.